

TUNING INSTRUCTIONS

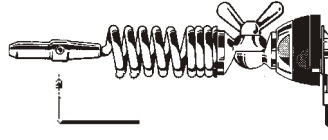

SMA 47/135

NOTE:

- Use the curves just as a guide. For fine-tuning please use an SWR-Meter.

TYPICAL S.W.R. RESPONSE

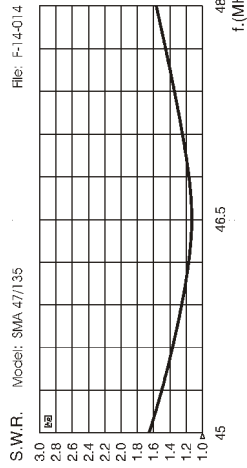

S.W.R. Model: SMA 47/135

File: F-14-014

File: F-14-014

TYPICAL S.W.R. RESPONSE

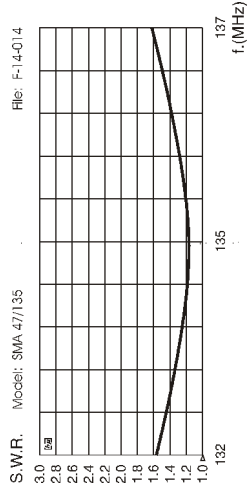

S.W.R. Model: SMA 47/135

File: F-14-014

TYPICAL TUNING DIAGRAM vs FREQUENCY

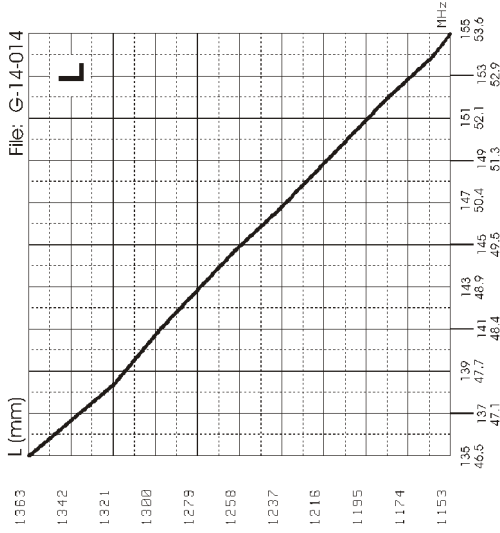

File: G-14-014

TYPICAL TUNING DIAGRAM vs FREQUENCY

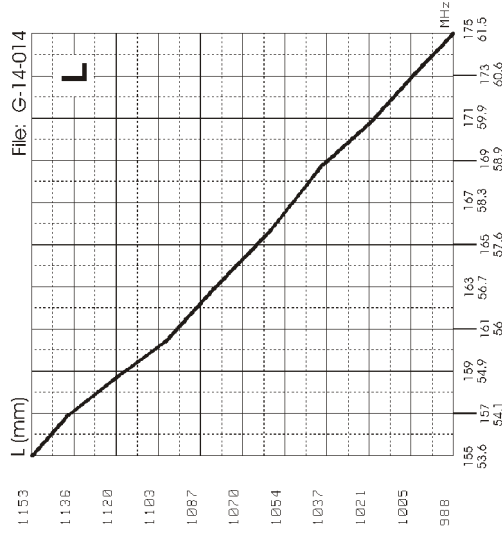

File: G-14-014

SM 48/140

SMA 47/135

6m & 2m Dual band VHF Mobile Antennas



SM 48/140



SMA 47/135

Installation Manual

DESCRIPTION

Dual band VHF vehicular antennas working on 6m band and 2m band by means of the attached cutting diagram. SM is made of tapered black fiberglass whip while SMA is made of tapered 1777 PH stainless steel of very high flexibility. Both models are supplied with a strong stainless steel spring. Available with "S" or "SL" mount on request.

SPECIFICATIONS

Electrical Data	
Type	: 1/4 Base Loaded for 46.5...61.5 MHz band
Frequency Range	: 5/8 for 135...175 MHz band : SM from 47.5 to 60.5 MHz & from 140 to 175 MHz : SMA from 46.5 to 61.5 MHz & from 135 to 175 MHz both models tunable by cutting
Impedance	: 50
Radiation	: Omnidirectional
Polarization	: Linear Vertical
Gain	: 0 dB ref. to a /4 whip for 46.5...61.5 MHz band : 2 dB ref. to a /4 whip for 135...175 MHz band
Bandwidth @ SWR 1.5	: SM 2 MHz @ 47.5 MHz; 2.8 MHz @ 140 MHz : SMA 2.5 MHz @ 46.5 MHz; 3.4 MHz @ 135 MHz
SWR @ res. freq.	: 1.3 both bands, both models
Max Power	: 100 Watts
Standard Mount	: "S", mounting hole 19 mm, cable 5m RG 58
Alternative Mount	: "SL", mounting hole 19 mm, cable 5m RG 58
Mechanical Data	
Materials	: SM Fiberglass, Stainless Steel, Nylon, Chromed Brass : SMA Stainless Steel 1777 PH, Nylon, Chromed Brass
Height (approx.)	: SM 1340 mm : SMA 1505 mm
Weight (approx.)	: 550 gr

MOUNT INSTALLATIONS

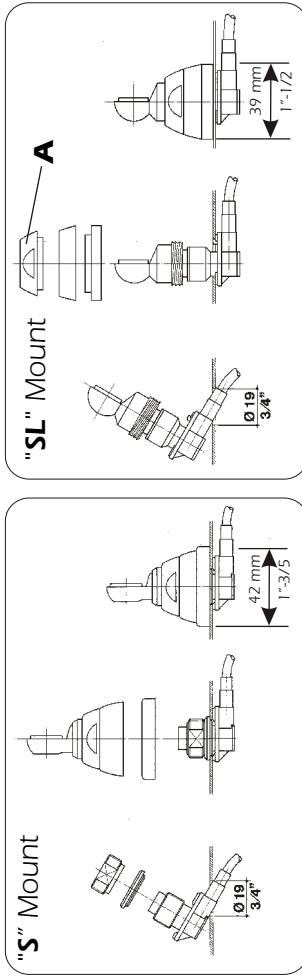

"SL" MOUNT REMARK: Be careful during installation do not use too much strength but tighten the metal ring **A** by means of the suitable tool. **TIGHTENING TORQUE: 4 Nm ± 10%**

PRECAUZIONE PER BASE "SL": Porre attenzione durante l'installazione. Non serrare con troppa forza ma avvitare l'anello metallico **A** utilizzando la chiave adeguata. **COPPIA DI SERRAGGIO: 4 Nm ± 10%**

TUNING INSTRUCTIONS



SM 48/140

NOTE:

- Use the curves just as a guide. For fine-tuning please use an SWR-Meter.

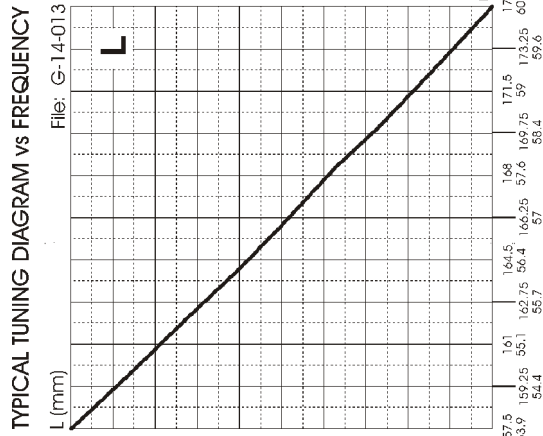
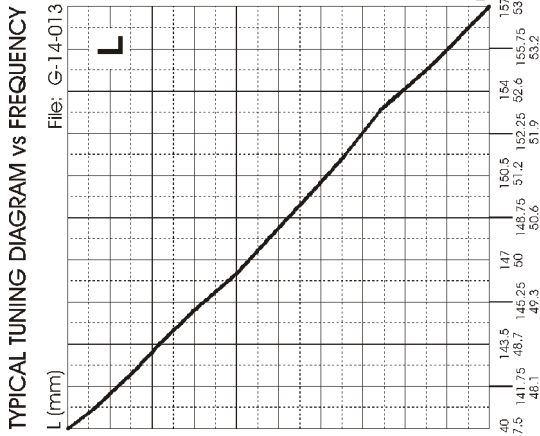

TYPICAL S.W.R. RESPONSE

