











ANTENNAS | HELI-17 SERIES

CIRCULAR POLARISED, BI-DIRECTIONAL MINE/TUNNEL ANTENNA

Wi-Fi; 2400 – 2500 MHz, 9 dBi



 2400 – 2500 MHz	 9 dBi	 Bi-Directional	 2.4 – 2.5 GHz	 IoT	 Machine to Machine
 2x2 MIMO possible with RHC & LHC	 IP 65	 Chemical Protection	 -40°C to +80°C	 Fire Resistant	

APPLICATION AREAS

-  Mining
-  Tunnelling
-  MASC Mining and Surface

- Circular Polarised HELI antenna provides enhanced signal propagation and connection stability within a tunnel
- Left-Hand Circular (LHC) & Right-Hand Circular (RHC) Polarised options available
- Bi-directional – radiates in both directions in a tunnel
- Ruggedized water and dust ingress protected (IP 65)
- Ideal for Mining & Tunnel M2M and IoT deployments

Product Overview

The HELI-17 forms part of a series of Mini-HELI antennas. These antennas are only mini in size relative to their bigger brothers, the HELI-3, HELI-4 & HELI-8, but offer medium to high gain, which makes these antennas ideal for mining tunnels where IoT/M2M connectivity is deployed and can also be used for coverage into the stopes.

The HELI-17 is a set of 2.4 GHz Wi-Fi antennas, radiating in both directions (i.e. bi-directional), which make them ideal for the coverage of the 2.4 GHz in mining and other type of tunnels. These antennas are typically used for the deployment of IoT within the tunnel to provide telemetry and mine automation. These antennas are available in both Left-Hand Circular (LHC) & Right-Hand Circular (RHC) polarised antenna elements to provide optimal decorrelation within a MIMO deployment when using the BRKT-45, resulting in optimum performance. The decorrelation is due to the polarisation difference and spatial diversity, between the two antenna elements, which enhances MIMO performance and RF reliability within a mining tunnel. The Wi-Fi connection propagates around tunnel bends in a Non-Line of Sight scenario and provides immunity to many Wi-Fi signal disrupting objects such as trains and drilling machinery which appear to obscure the tunnel.

Features

- Single port 2.4 GHz Wi-Fi antenna
- This antenna is especially designed for mining and other types of tunnels where rapid extension of network is required
- Bi-directional – radiates in both directions in a tunnel
- Left & Right-hand Circular Polarised available (for MIMO)
- Intrinsically safe version available on request

Application Areas

- Supplementing fibre/leaky feeder cable “Hotspots” to areas to enhance mobility or extend networks to inaccessible areas
- Underground telemetry and automation
- Creating of complete underground in tunnel wide data networks and internet/LTE connectivity
- Seamless connection to personnel using cellular phones and smart devices and tablets



2x HELI-17 antennas mounted on the BRKT-45 for MIMO application

HELI-17



Frequency Bands

The Heli-17 is a Wi-Fi / ISM antenna that works from | 2400 – 2500 MHz |

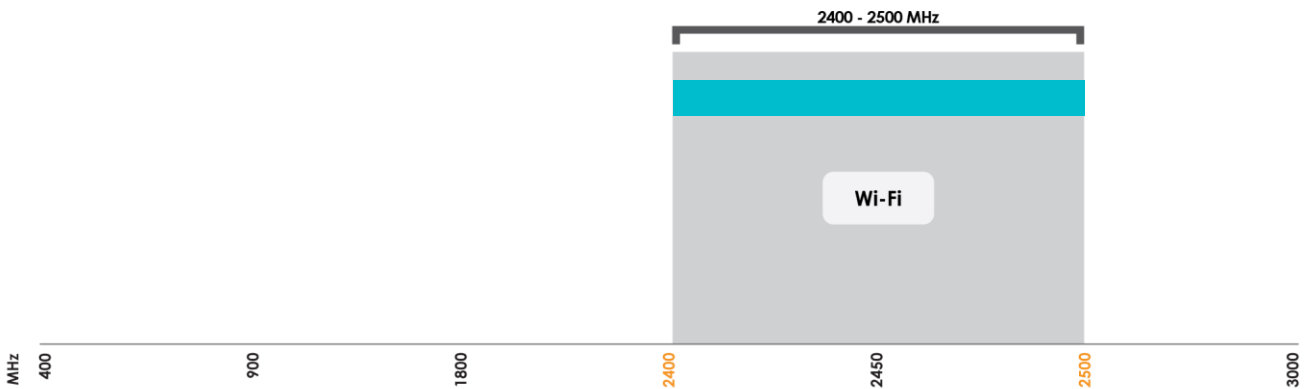

Indicates the Wi-Fi bands on which Heli-17 works

Antenna Overview

	
Port	1
Frequency Bands	2400 – 2500 MHz
Peak Gain	9 dBi
Coax Cable Type	RG-141
Coax Cable Length	400mm
Connector Type	N-Type (M)
<i>*The coax cable & connector are factory mounted to the antenna</i>	

Electrical Specification

Frequency Bands:	2400 – 2500 MHz
Gain (Max):	9 dBi
VSWR:	<1.5:1
Feed Power Handling:	Over 90% of the band 30 W
Input Impedance:	50 Ohm (nominal)
Polarisation:	Circular Polarised (LHC or RHC)
Coax Cable Loss:	0.84 dB /m @ 2.4 GHz
DC Short:	N/A

Product Box Content

Antenna:	A-HELI-0017-V3-01
----------	-------------------

Ordering Information

Commercial name:	HELI-17
a) Right-hand Circular Version	
Order product code:	A-HELI-0017-V3-01-R
EAN number:	6009710921388
b) Left-hand Circular Version	
Order product code:	A-HELI-0017-V3-01-L
EAN number:	6009710921371

Note: For MIMO application, order both Right-Hand Circular and Left-Hand Circular antennas.

Mechanical Specification

Product Dimensions:	631 mm x 143 mm x 116 mm
Packaged Dimensions:	660mm x 165mm x 140mm
Weight:	0.70 kg
Packaged Weight:	1.3 kg
Radome Material:	UV Stable ASA
Radome Colour:	Grey Pantone-424C
Mounting Type:	Ceiling mounted

Environmental Specifications, Certification & Approvals

Wind Survival:	≤120 km/h
Temperature Range (Operating):	-40°C to +80°C
Environmental Conditions:	Outdoor/Indoor
Water Ingress Protection Ratio/Standard:	IP 65
Salt Spray:	MIL-STD 810G/ASTM B117
Operating Relative Humidity:	Up to 98%
Storage Humidity:	5% to 95% - non-condensing
Storage Temperature:	-40°C to +80°C
Enclosure Flammability Rating:	UL 94-HB
Impact Resistance:	IK 08
Product Safety & Environmental:	Complies with CE and RoHS standards



Antenna Performance Plots

VSWR

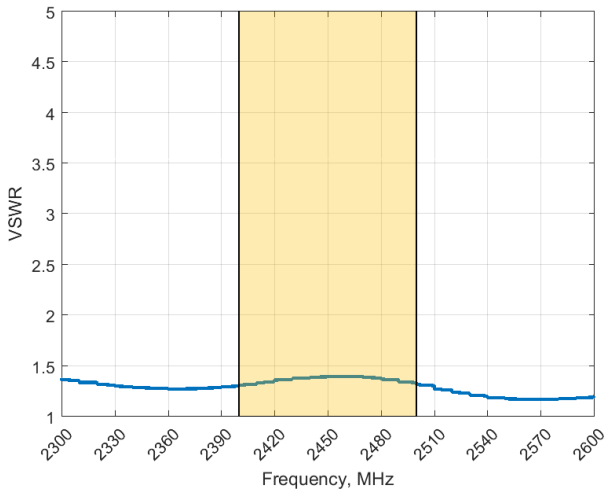

Voltage Standing Wave Ratio (VSWR)*

VSWR is a measure of how efficiently radio-frequency power is transmitted from a power source, through a transmission line, into a load. In an ideal system, 100% of the energy is transmitted which corresponds to a VSWR of 1:1.

The HELI-17 delivers superior performance across all bands with a VSWR of <1.5:1 or better across 90% of the bands.

*VSWR measured with 400mm low loss cable

GAIN (EXCLUDING CABLE LOSS)

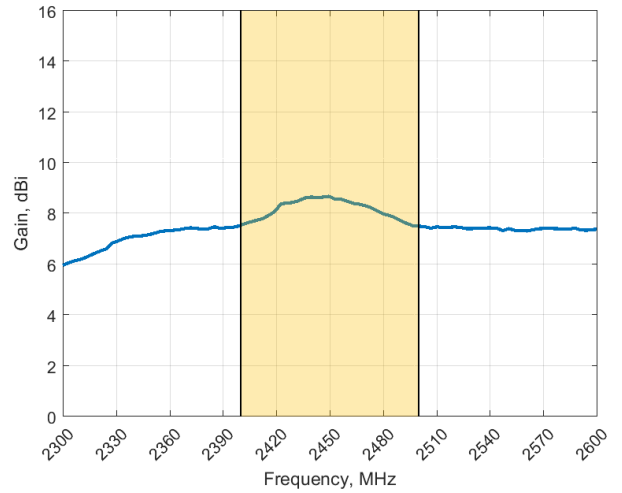

Gain* in dBi

9 dBi is the peak gain across all bands from 2400 – 2500 MHz

*Antenna gain measured with circular polarised standard antenna

Technical Drawings

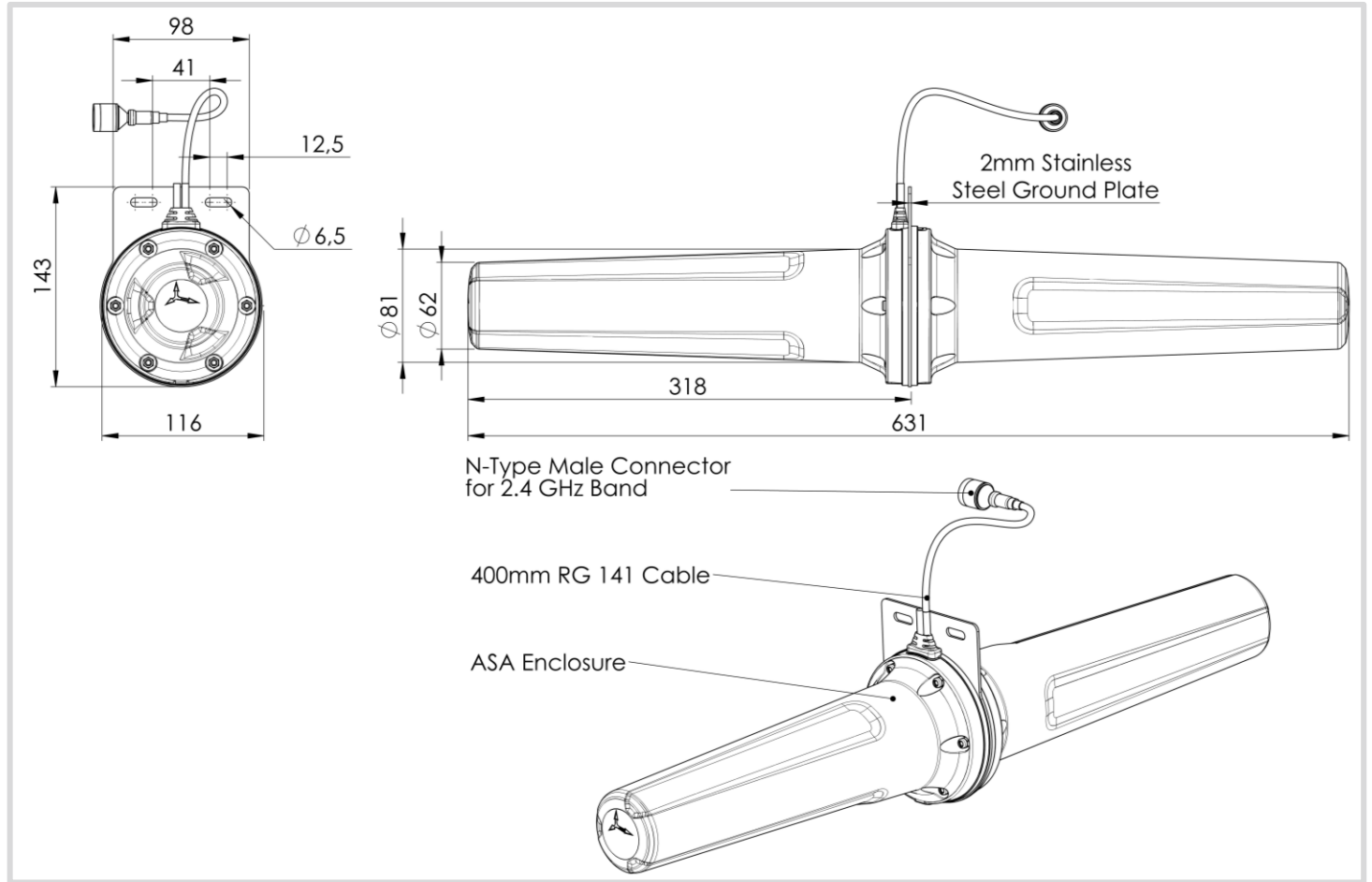

Radiation Patterns

Azimuth

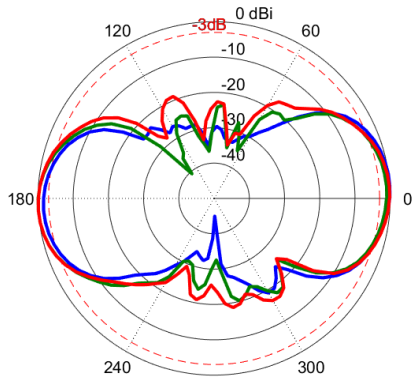

- 2400 MHz
- 2450 MHz
- 2500 MHz

Elevation

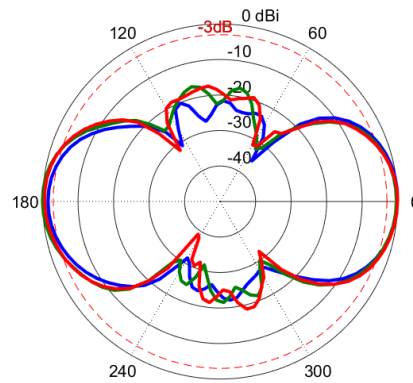

- 2400 MHz
- 2450 MHz
- 2500 MHz

Mounting Options



Base Mount

The antenna can be suspended directly using the two slots on its base.

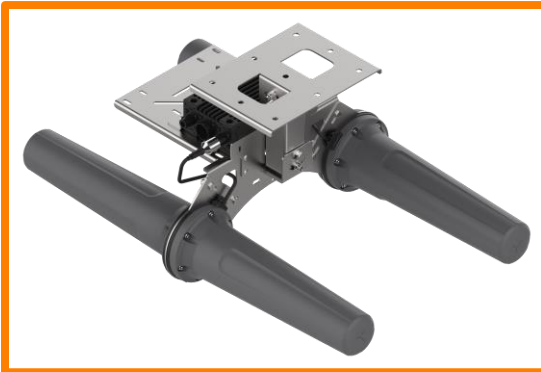

Ceiling Mount (MIMO) - Optional

An optional Multi-directional swivel bracket is available for mounting 2 x miniHELI antennas (right-hand circular and left-hand circular polarised antennas) to a ceiling for MIMO application.

This option uses A-BRKT-045-V2-01.



Roof Bolt Mount (MIMO) - Optional

This optional 20mm roof bolt mounting bracket attachment is used in conjunction with BRKT-45 for mounting to standard mine roof bolts.

This option uses A-BRKT-047-V1-01.

Additional Accessories



A – BRKT – 045 -V2 - 01

Ceiling mounting bracket for holding miniHELI right-hand and left-hand circular polarised antennas.



A – BRKT – 047 -V1 - 01

Ceiling 20mm Rod mounting bracket attachment to use with BRKT-45.

See accessories technical specifications on www.poynting.tech

CONTACT POYNTING

Poynting Antennas (Pty) Ltd - Head Office

Unit 4, N1 Industrial Park,
Landmarks Avenue,
Samrand, 0157, South Africa

Phone: +27 (0) 12 657 0050

E-mail: info@poynting.tech

International Email: sales-global@poynting.tech

Poynting Europe

Regus Business Center Neue Messe Riem
Kronstadter Straße 4
81677 München
Germany

Phone: +49 89 7453 9002

E-mail: sales-europe@poynting.tech

Poynting USA

1804 Owen Court, Suite 104,
Mansfield,
TX 76063
USA

Phone: +1 817 533-8130

E-mail: sales-us@poynting.tech